

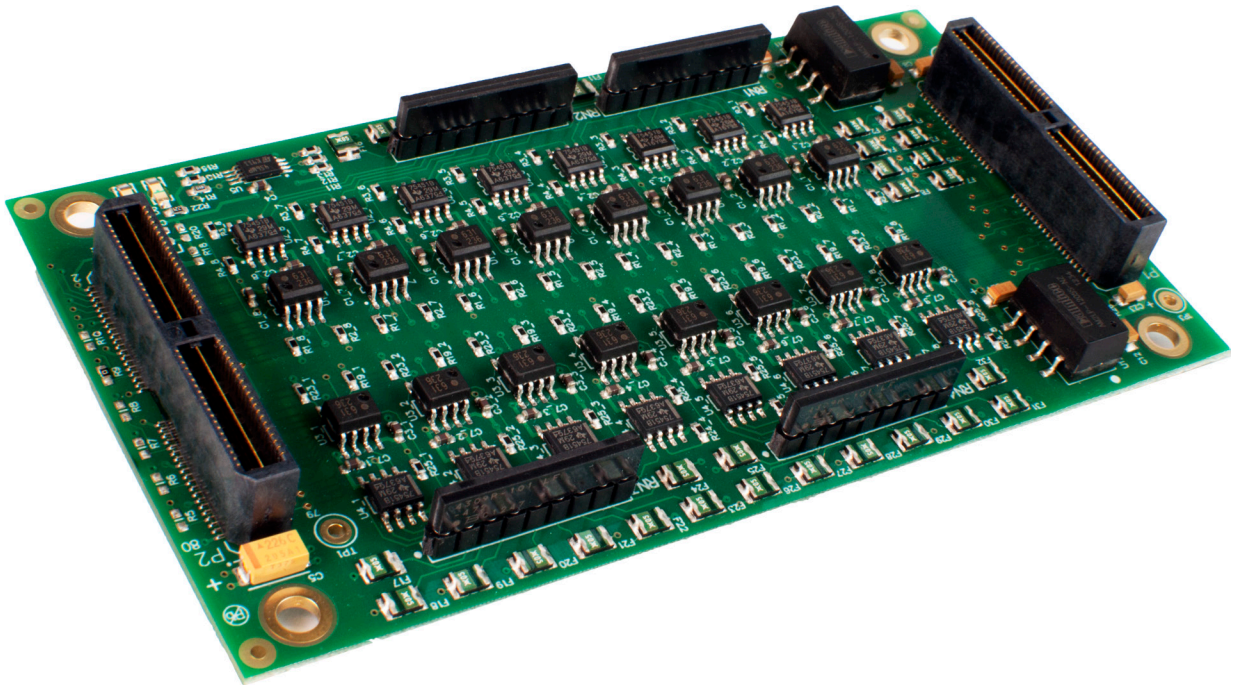

OPAL-RT



OP5359 User Manual

32 Digital Output Module







Published by

Opal-RT Technologies, Inc. 1751 Richardson, suite 2525 Montréal (Québec) Canada H3K 1G6

www.opal-rt.com

SYMBOL DEFINITIONS

The following table lists the symbols used in this document to denote certain conditions:

Symbol	Definition
	ATTENTION: Identifies information that requires special consideration
	TIP: Identifies advice or hints for the user, often in terms of performing a task
	REFERENCE _ INTERNAL: Identifies an additional source of information within the bookset.
CAUTION	Indicates a situation which, if not avoided, may result in equipment or work (data) on the system being damaged or lost, or may result in the inability to properly operate the process.
	Indicates a situation where users must observe precautions for handling electrostatic sensitive devices.
	CAUTION: Indicates a potentially hazardous situation which, if not avoided, may result in minor or moderate injury. It may also be used to alert against unsafe practices.
	WARNING: Indicates a potentially hazardous situation which, if not avoided, could result in serious injury or death.

CONTENTS

- INTRODUCTION 7**
 - FEATURES.....7
- MODULE INSTALLATION 7
- CIRCUIT LAYOUT DIAGRAMS..... 7
 - OUTPUTS.....8
- VUSER POWER CONFIGURATION 9**
 - OUTPUTS:9
- DB37F PIN ASSIGNMENTS..... 10
- TYPICAL APPLICATION..... 10
- SPECIFICATIONS 11



INTRODUCTION

The OP5359 is a part of the OP5000 series of optional, versatile signal conditioning modules for OPAL-RT's state of the art HIL (hardware-in-the-loop) systems. Designed for OPAL-RT's simulation systems, the OP5359 provides open collector digital output signals with specific voltage conditioning. The optical isolation of the OP5359 outputs make it ideal for environments where voltage isolation is required.

The OP5359 type B mezzanine is compatible with OPAL-RT products that support type B mezzanines.

FEATURES

- 32 optically isolated, open collector output channels
- Outputs can be grouped in parallel for any size bus simulation
- All outputs accept voltage up to 30V and the output current is up to 100mA.

MODULE INSTALLATION

The OP5359 digital output signal conditioning module must be inserted onto an OPAL-RT carrier board that supports type B mezzanines modules.

Circuit Layout Diagrams

When the OP5359 is installed on the carrier board, only the top of the circuit board is visible, as shown in Figure 2. The connectors are located on the bottom of the board (see Figure 1) and fit snugly into the connectors on the carrier

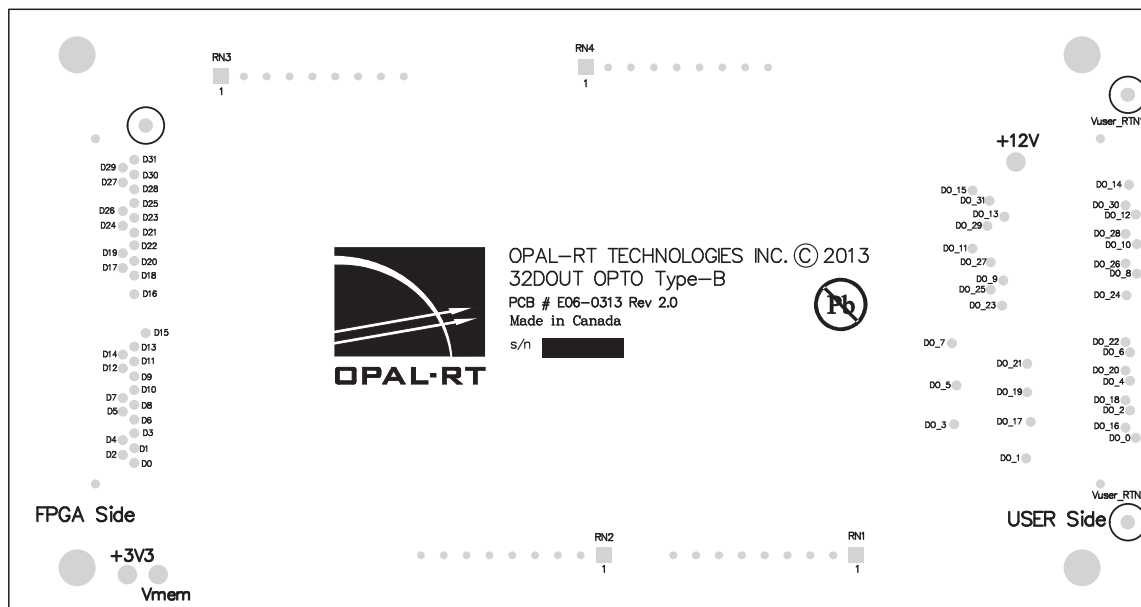

Figure 1: OP5359 digital signal conditioning module

OUTPUTS

Each optically isolated output has an open collector transistor. It can sink up to 100 mA continuous, and supports user voltage up to +30V. It is current protected by resettable fuse (PTC). The optical isolation circuitry is powered by an internal isolated DC supply.



CAUTION: If Vuser is connected to the simulator, the output voltage DOUT would be the same as Vuser as long as no RT-LAB model is running (output transistor is open).

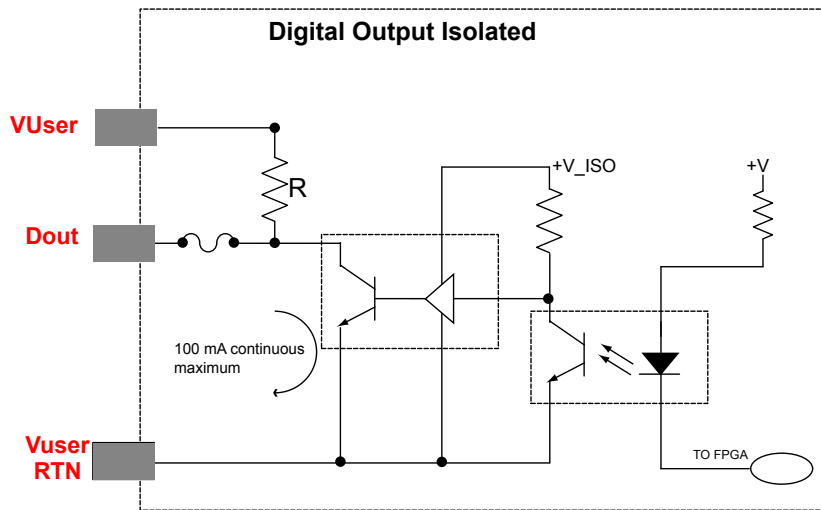

Figure 2: Isolated Digital Output Drawing

As long as the transistor is in its OFF state, the digital line/output is pulled high by the pull-up resistor to Vuser.

When the the transistor is turned ON, the line is set to the low state (Vuser RTN).

NOTE:	+V_ISO	Isolated voltage from isolated DC-DC converters
	+V	Internal voltage from simulator, non-isolated
	Vuser/VUser RTN	External voltage supplied by user (4V to 30V)

VUSER POWER CONFIGURATION

The following resistors are used for the OP5359. The part numbers provided are for reference purposes only. Part numbers may differ according to supplier or country.

	Voltage range (Volts - continuous)	Resistor value (Ω) (R)	Resistor Network Bourns Part Number
Digital Output	0-8	270	4309R-101-271 LF / 4309H-101-271 LF
	0-15	1000	4309R-101-102 LF / 4309H-101-102 LF
	0-30	4700 (default)	4309R-101-472 LF / 4309H-101-472 LF

Table 1: Digital Output Voltage and Resistor Values



WARNING: ensure that the proper resistor is installed to obtain desired rise time. Failure to do so may result in damage to the OP5359 board or host setup.

OUTPUTS:

Make sure you match pin 1 indicator with pin 1 on the module. when using a SIP-9 isolated resistor network, an additional resistor in parallel with the output circuit will increase the current. Make sure that the current does not exceed 100 A per output.

Each output resistor network affects 8 digital output channels. Refer to the Resistor Network table below for the relationship between the resistor network and output channels. Use the following formula to ensure safe power dissipation.

Resistor values must be calculated according to the output voltage to ensure that power does not exceed the resistor pack limit, which is 200mW:

$$R = \frac{V^2}{P} \quad R = \frac{V^2}{0.2W}$$

Example with $V_{user} = 12V$:

$$R = 144/0.2 = 720 \text{ Ohms minimum}$$

Note that output rise times depend on the resistor. The higher the resistance, the slower the rise time and vice versa.

Resistor network	Channel bank
RN1	00-07
RN2	08-15
RN3	16-23
RN4	24-31

Table 2: Dout Resistor Network by Channel Bank

DB37F PIN ASSIGNMENTS

Connector P1 Ch. 0-15				Connector P2 Ch. 16-31			
DB37F	OP5359 pin assignment	DB37F	OP5359 pin assignment	DB37F	OP5359 pin assignment	DB37F	OP5359 pin assignment
1	+DOUT00	20	-DOUT00	1	+DOUT16	20	-DOUT16
2	+DOUT01	21	-DOUT01	2	+DOUT17	21	-DOUT17
3	+DOUT02	22	-DOUT02	3	+DOUT18	22	-DOUT18
4	+DOUT03	23	-DOUT03	4	+DOUT19	23	-DOUT19
5	+DOUT04	24	-DOUT04	5	+DOUT20	24	-DOUT20
6	+DOUT05	25	-DOUT05	6	+DOUT21	25	-DOUT21
7	+DOUT06	26	-DOUT06	7	+DOUT22	26	-DOUT22
7	+DOUT07	27	-DOUT07	8	+DOUT23	27	-DOUT23
9	+DOUT08	28	-DOUT08	9	+DOUT24	28	-DOUT24
10	+DOUT09	29	-DOUT09	10	+DOUT25	29	-DOUT25
11	+DOUT10	30	-DOUT10	11	+DOUT26	30	-DOUT26
12	+DOUT11	31	-DOUT11	12	+DOUT27	31	-DOUT27
13	+DOUT12	32	-DOUT12	13	+DOUT28	32	-DOUT28
14	+DOUT13	33	-DOUT13	14	+DOUT29	33	-DOUT29
15	+DOUT14	34	-DOUT14	15	+DOUT30	34	-DOUT30
16	+DOUT15	35	-DOUT15	16	+DOUT31	35	-DOUT31
17		36		17		36	
18	Vuser 1	37	Vrtn 1	18	Vuser 2	37	Vrtn 2
19				19			

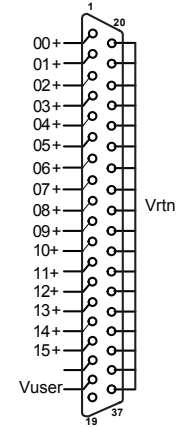
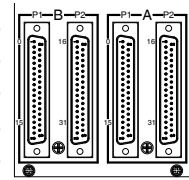

TYPICAL APPLICATION

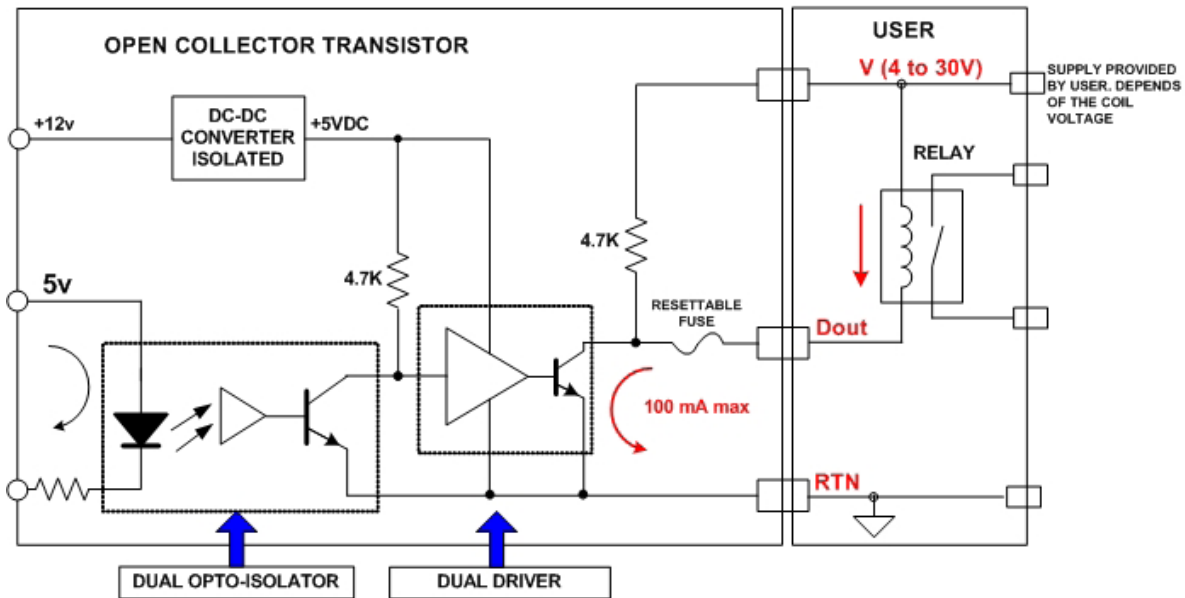

Figure 3: OP5359 typical application diagram

SPECIFICATIONS

Product name	OP5359
Part number	126-0313
Number of channels	32 digital outputs
Isolation:	Optical isolator
Output Drive:	Open Collector Transistor
Output Current max:	100 mA continuous
Output Protection :	150 mA Resettable Fuse
Output Voltage range:	4 to 30 Vdc
Pull-Up Load resistor network:	Socket mounted
Delay Low-to-High:	100 ns with 1 k Ω R _L
Delay High-to-Low:	50 ns
Rise/Fall times:	R _L dependant / 6 ns
Power Isolation:	On-board DC to DC isolated converter
Dimensions	6.60 cm x 12.50 cm (2.6" x 4.92")
Operating temperature	10 to 40 °C (50 to 104°F)
Storage temperature	-55 to 85°C (-67 to 185°F)
Relative humidity	10 to 90%, non condensing
Maximum altitude	2,000 m (6562 ft.)

CONTACT

OPAL-RT Corporate Headquarters

1751 Richardson, Suite 2525
Montréal, Québec, Canada
H3K 1G6
Tel.: 514-935-2323
Toll free: 1-877-935-2323

Technical Services

www.opal-rt.com/support

Note:

While every effort has been made to ensure accuracy in this publication, no responsibility can be accepted for errors or omissions. Data may change, as well as legislation, and you are strongly advised to obtain copies of the most recently issued regulations, standards, and guidelines.

This publication is not intended to form the basis of a contract.



UG15-13013-RVN 1.0

11/2015

© OPAL-RT Technologies Inc.