



GENERAL DESCRIPTION

The PEB series modules are designed for the implementation of low-voltage power converters. The mechanical design is tailored for 19" rack integration with simple interconnections and direct connection to a BoomBox, or any other control platform.

Each module contains a half-bridge, corresponding to two power semiconductors. Two identical modules can be associated to form a full bridge.

Direct access to the gating signals is offered using optical fiber inputs, while embedded measurement circuits provide direct analog outputs related to the DC link voltage or the AC output current using galvanically-isolated sensors.

The PEB modules are available either in a water-cooled version (-W variant) that allows an extreme power density, or in a more versatile air-cooled version (-A) that may be used without any additional cooling hardware.

TYPICAL APPLICATIONS

The modules are ideally suited to build up ambitious prototypes of any type of low-voltage power converters, ranging from conventional three-phase inverters to multilevel topologies. Typical power ratings are ranging between 6–10 kW depending on the nominal DC link voltage, the cooling variant and switching frequency.

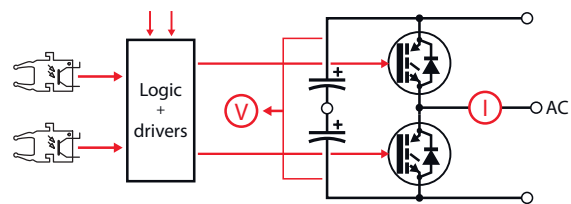
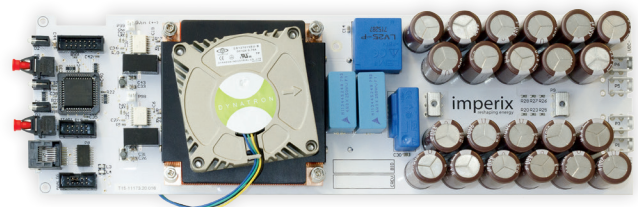

KEY FEATURES AND SPECIFICATIONS

- Half-bridge topology
- 800V nominal DC link voltage
- 32 A continuous RMS current
- 120 W TDP envelope
- SMPD-type IGBTs (IXYS semiconductors)
- Up to 50kHz switching frequency
- ± 3 kV galvanic isolation (1 s) / ± 560 V (permanent)
- 2 optical inputs / 1 analog output
- Embedded voltage and current measurement
- 100 x 330 mm Eurocard form factor

MAIN COMPONENTS

Component	Devices	Main specifications
Power switches	2x IXYS IGBTs with diodes MMIX 1Y 100N120 C3 H1	See below or device datasheet
Capacitors	260 μ F @800V (2 banks of 11x 47 μ F in series)	900V, 10'000h @105°C
Drivers	4x Avago ACPL-333J	2.5 A, 50 kV/us, $V_{IORM} = 1kV_{RMS}$
Isolated DC/DC Converters	3x Recom R05P215S/P	5-15 V, 2W, $V_{ISO} = 3.2kV$
Current sensor	1x LEM LAH50-P	$\pm 50A$, 200kHz, $\pm 0.25\%$ accuracy
Voltage sensor	1x LEM LV25-P with $R_{IN} = 100k\Omega$	50kHz, $\pm 0.5\%$ accuracy
Heatsinks	1x Dynatron G199	0.33 °C/W at full speed
CPLD	1x Altera EPM7064SLC44	5ns, 1'250 gates
Optical receivers	2x Avago HFBR-2521ETZ	POF, 660 nm

ABSOLUTE MAXIMUM RATINGS

Parameter	Symbol	Test conditions	Min.	Typ.	Max.	Unit
Maximum DC link voltage ¹	V_{DC}		-	800	-	V
Maximum DC bus ripple current (at 100Hz) ²	I_{RIPPLE}		-	9.5	-	A
Maximum turn-off current	I_{MAX}		-	200	-	A
Maximum working isolation voltage	V_{IORM}		-	1.0	-	kV _{PEAK}
Highest allowable short-term isolation voltage (1s)	V_{IOTM}		-	3.0	-	kV _{PEAK}
Supply voltage	5V0		4.2	5.0	5.8	V
	12V ³		4.5	12.0	14.0	V
Highest allowable junction temperature	$T_{J(max)}$		-	150	-	°C

SEMICONDUCTOR PARAMETERS

Parameter	Symbol	Test conditions	Min.	Typ.	Max.	Unit
Breakdown voltage	V_{CES}		-	1200	-	V
Nominal current ⁴	I_{nom}	$F_{SW} = 10 kHz$	-	32	-	A
Maximum continuous drain current ⁵	I_{C110}	$T_J = 110^\circ C$	-	40	-	A
	I_{C25}	$T_J = 25^\circ C$	-	92	-	A
Maximum continuous diode forward current	I_{F90}	$T_J = 110^\circ C$	-	34	-	A
Saturation voltage	$V_{CE,sat}$	$I_C = I_{nom}, T_J = 110^\circ C$	-	2.1	-	V
Diode forward voltage	V_F	$I_F = I_{nom}, T_J = 110^\circ C$	-	1.6	-	V
Transistor turn-on energy	E_{ON}	$I_C = I_{nom}, V_{DC} = 600V$	-	3.1	-	mJ
Transistor turn-off energy	E_{OFF}	$I_C = I_{nom}, V_{DC} = 600V$	-	1.5	-	mJ
Diode recovery energy	E_{rr}	$I_C = I_{nom}, V_{DC} = 600V$	-	1.5	-	mJ
Transistor thermal resistance junction-to-heatsink ⁶	$R_{thJH,t}$		-	-	0.35	°C/W
Diode thermal resistance junction-to-heatsink ⁶	$R_{thJH,d}$		-	-	0.54	°C/W
Case-to-heatsink isolation voltage	V_{ISO}	1 min		2.5		kV

¹ The maximum DC link voltage is defined by the specifications of the electrolytic capacitors. Hence, few short-term overvoltages can be tolerated, provided that they involve limited amounts of energy.

² The maximum ripple current is defined by the equivalent series resistance (ESR) of the capacitors and relates to Joule losses and lifetime considerations. Therefore, this value can be exceeded, provided that the operating temperature of the capacitors remains low.

³ The 12V is entirely independent from the module and serves only to supply optional cooling fans that can be mounted on the heat-sinks.

⁴ In cold conditions, the maximum operating current is limited by the power semiconductors. Otherwise, the current rating of the module is limited by the power envelope of the heatsink (about 120 W).

⁵ For short-term durations, higher currents can be tolerated. See absolute maximum ratings.

⁶ The total average thermal resistance junction-to-air is therefore approximately 0.8 °C/W, leading to a junction temperature of typically 120 to 130°C for a thermal design power (TDP) of 120 W, assuming an ambient air temperature of 25°C.

MECHANICAL DATA

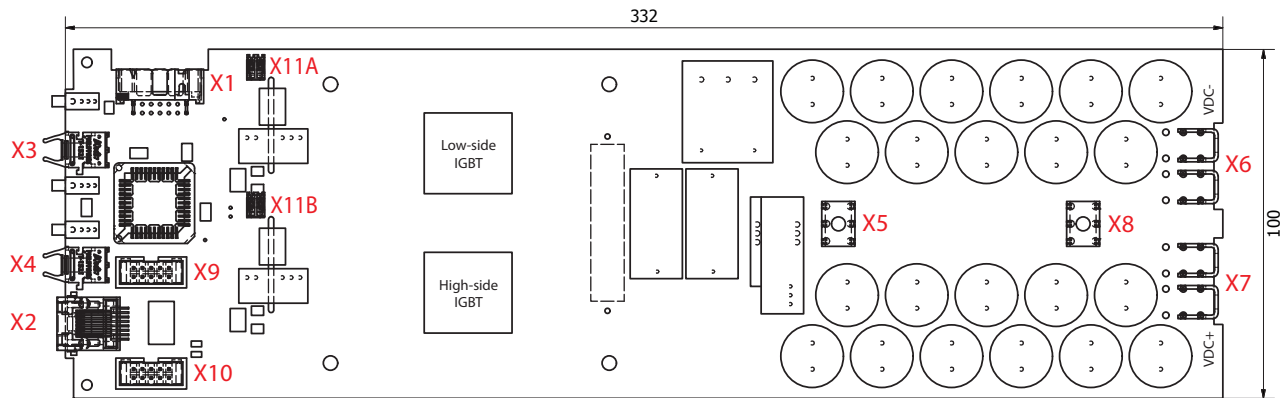

Fig.1. Electrical and optical terminals of the PowerTrench modules.

Designation	Role	Designation	Role	Designation	Role
X1	Digital board-to-board connector Optional power supply	X11A	Primary 5V power supply connector	X11A	Primary 5V power supply connector
X2	Analog output Sensor power supply	X11A	Secondary 5V power supply connector	X11A	Secondary 5V power supply connector
X3	Top gate signal (optical)	X5	AC power terminal	X5	AC power terminal
X4	Bottom gate signal (optical)	X6	DC- power terminal	X6	DC- power terminal
X9	CPLD programming JTAG	X7	DC+ power terminal	X7	DC+ power terminal
X10	Analog expansion connector Current/voltage selection jumper	X8	DC bus mid-point terminal	X8	DC bus mid-point terminal

CURRENT MEASUREMENT CHARACTERISTICS

Parameter	Symbol	Note	Min.	Typ.	Max.	Unit
Optimized accuracy range	I_{OPT}		-	±50	-	A
Measuring range	I_{FS}		-	±110	-	A
Nominal sensitivity	G		-	50.0	-	mV/A
Uncalibrated sensitivity error	G_{ERR}	$T_A = 25^\circ\text{C}$	-	±0.25	-	%
Offset (output-referred)	I_O	$T_A = 25^\circ\text{C}$	-	-	±150	μA
		$T_A = 0-70^\circ\text{C}$	-	±100	±300	μA
Bandwidth	f_{3dB}	-1 dB	-	200	-	kHz
Measurable slope	dI/dt		200	-	-	A/μs
Step response time	t_R	0 to 45 A	-	-	0.5	μs
Recommended current-to-voltage conversion resistance	R_M	with ±15V power supplies	100	-	350	Ω
Maximum working isolation voltage	V_{IORM}	EN50178, basic insulation requirements	-	1.0	-	kV

VOLTAGE MEASUREMENTS CHARACTERISTICS

Parameter	Symbol	Note	Min.	Typ.	Max.	Unit
Measuring range	V_{OPT}		0	-	1000	V
Nominal sensitivity	G		-	2.5	-	mV/V
Uncalibrated sensitivity error ⁷	G_{ERR}	25°C, including resistive divider	-	±1.3	±1.8	%
Offset (output-referred)	I_O	$T_A = 25^\circ\text{C}$	-	-	±150	μA
		$T_A = 25-70^\circ\text{C}$	-	±100	±350	μA
Gain error over temperature	$G_{ERR,t}$	$T_A = 25^\circ\text{C}$ to 100°C		±0.1		%
Bandwidth ⁸	f_{3dB}		-	50	-	kHz
Step response time	t_R	0 to 700 V	-	35	-	μs
Recommended current-to-voltage conversion resistance	R_M	with ±15V power supplies	0	-	188	Ω
Maximum working isolation voltage	V_{IORM}	EN50178, basic insulation requirements	-	1.6	-	kV

⁷ When calibrated under stabilized operating temperature conditions, superior performance can be achieved. ⁸ The bandwidth is related to the L/R time constant of the primary resistor and the sensor inductance.

POWER SUPPLIES

Each module requires a single 5V power supply for its local gate drive circuit, plus an independent 12V supply for the cooling fan. Recommended cabling strategies are shown in Fig. 2-Fig. 4. They make use of either the X1 or X11 connectors (Fig. 1), plus an independent cable for the cooling fan. Typical power consumptions are < 250 mA @5V and < 500 mA @12V.

For a low of module count, a basic 2-pos MTA100 connector can be used (Fig. 2). Prefer 22 AWG cable or larger for minimum voltage drop along power supply lines.

- 2-pos MTA100-type terminal, [here](#).
- Convenient assembling tool, [here](#).

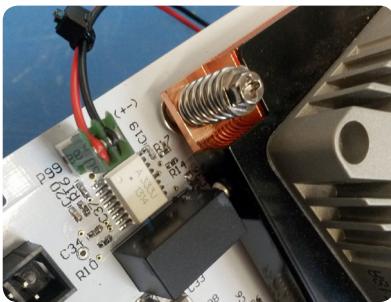

Fig. 2. 5V, direct connection.

With several modules per rack enclosure, a flat ribbon cable is preferable (Fig. 3). Use all 5V supply lines (pins 1, 2, 13, 14) to minimize voltage drop across all modules.

- 14-pos flat IDC cable, [here](#).
- [14-pos IDC female connector, here](#).

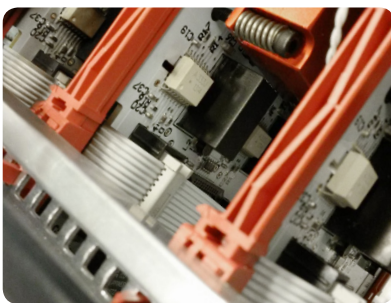

Fig. 3. 5V, daisy chaining.

For fan(s), computer accessories may be useful to simplify the wiring. In most applications, a variable voltage source (in order to adjust fan speed / noise) is recommended.

- Y-type fan splitter, [here](#).

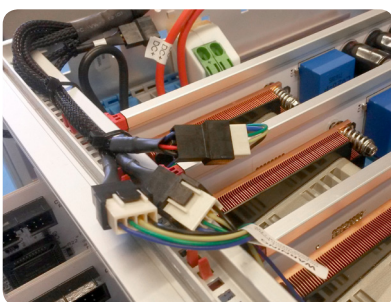

Fig. 4. 12V, direct connection.

POWER CONNECTIONS

Each module possesses 4 power terminals, indicated by terminals X5–X8 (Fig. 1). All terminals use M4 screws. Fig. 5 to Fig. 6 illustrate several connection variants. As a general rule of thumb, imperix recommends not to exceed 4 A/mm² within all conductors. For systems intended for long-term usage, lower current densities may be advisable. Recommended ring-type terminals are:

- M4 hole, 6 mm², circular-tubular, [here](#).
- M5 hole, 10 mm², circular-tubular, [here](#).
- M5 hole, 16 mm², circular-tubular, [here](#).



Fig. 5. Copper busbars.

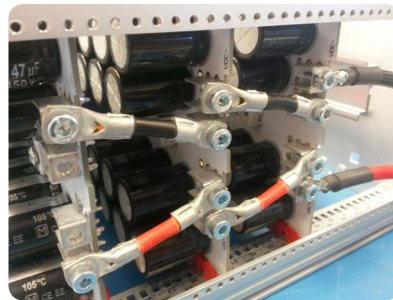

Fig. 6. Direct wired connections.

OPTICAL GATING SIGNALS

The gate drive inputs for both semiconductors are directly available through X3 and X4 (Fig. 1). They correspond to the high-side and low-side switches, respectively.

- 1 m pre-assembled fiber, [here](#).
- 5 m pre-assembled fiber, [here](#).

By default, no special coding is required: light on simply implies that the switch is on and vice-versa. Alternative strategies (e.g. PWM / enable signals) are possible. Please consult with imperix support for assistance with the re-programming of the CPLD.

MEASUREMENT OUTPUT

PowerTrench modules possess two sensors:

- A [LEM LAH50-P](#) sensors on the AC output current.
- A [LEM LV25-P](#) on the local DC link voltage.

Either of these sensors can be connected to the RJ45-type output connector (X2). They can be used alternatively by selecting the desired measurement through the jumper placed in the X10 analog connector. The corresponding positions are indicated in Fig. 7.

For both sensors, a $\pm 15V_{DC}$ power supply must be provided through the X2 connector according to the pinout indicated in Table 1.



Fig. 7. Jumper positions in order to route one of the measurements to the analog output.

Pin	Color	Description
1	orange stripe	+15 V
2	orange solid	
3	green stripe	0 V
4	blue solid	Signal output / current output
5	blue stripe	N.A.
6	green solid	0 V
7	brown stripe	-15 V
8	brown solid	

Table 1. Analog signal assignments (right to left when facing X2).

Both sensors provide non-differential current-type output signals. As such, they are meant to be connected to low impedance inputs, such as the 100Ω single-ended input mode of the BoomBox.

When used along with the BoomBox, the recommended analog input configurations are indicated in Table 2. For closed-loop control applications, estimations of the total acquisition delays are provided in Table 3.

Sensor	Sensitivity	Recommended BoomBox config.
LEM LAH50-P	50mV/A – (1/20)	Low-Z, G=2
LEM LV25-P	2.5mV/V – (1/400)	Low-Z, G=4

Table 2. Recommended configuration of the BoomBox.

Sensor	Sensor delay	Filter delay	Software delays
LEM LAH50-P	< 0.5μs (0 to ±45 A)	on: 40μs off: 0ns	ADC-to-FPGA: < 2.7μs FPGA-to-DSP: < 1.8μs For all 16 channels
LEM LV25-P	< 10μs (0 to 720 V)		

Table 3. Estimated acquisition delays using the BoomBox.

Recommended maximum values of the safety thresholds are shown in Table 4. These values may be reduced according to the desired operating conditions.

Sensor	Example operating range	BoomBox thresholds config.
LEM LAH50-P	[-60 A; +60 A]	[-6.0 V; +6.0 V]
LEM LV25-P	[0; +820 V]	[-0.2 V; +8.2 V]

Table 4. Recommended safety thresholds.

COUPLING OF MODULES

Two modules can be associated using the X1 digital connector (Fig. 1). This allows to share some signals across both modules (fault, enable, gating signals, reset, etc.).

To do so, both CPLDs must be re-programmed with an appropriate firmware. Please consult with imperix support for assistance with the re-programming of the CPLD.

SEMICONDUCTOR LOSSES

The semiconductor losses can be estimated from their specific datasheet. The corresponding key parameters are summarized on page 2.

- 600V IGBT [MMIX 1X100 N60 B3H1](#) (old device).
- 600V IGBT [MMIX 1X200 N60 B3H1](#) (new device).
- 1200V IGBT [MMIX 1Y 100N120 C3 H1](#).

In order to avoid over-heating and the likely destruction of the semiconductor switches, the total power losses must be lower than the thermal design power (TDP) of the heatsink (and fan), namely:

- Water-cooled variant: 250W
- Air-cooled variant: 120W

Warning:

As there is no on-board mechanism preventing the overheating of the power semiconductors, it is crucial to pay careful attention to the operating temperature in case of operation close to the limits.

GALVANIC ISOLATION

The modules offer galvanic isolation of the power stage with respect to the local control / gate drive section. All components are consistent with isolation ratings ideally suited for low-voltage systems.

Imperix recommends to maintain the gate drive section grounded, while the complete power stage may remain entirely floating. In such a case, no point of the power stage of any module shall exceed the maximum working isolation voltage specified in the absolute maximum ratings (1kV). Nevertheless, higher voltages can be tolerated during transients.

Regarding possible ways to use PowerTrench modules in higher voltage applications (e.g. multilevel systems), please consult with the imperix, as suitable solutions are under development.

MECHANICAL ASSEMBLY

Imperix recommends to mount parallel modules at least every 9 holes (45.7 mm) for best cooling performance. This way, up to 9 PowerTrench modules can be mounted within a 19" rack enclosure.

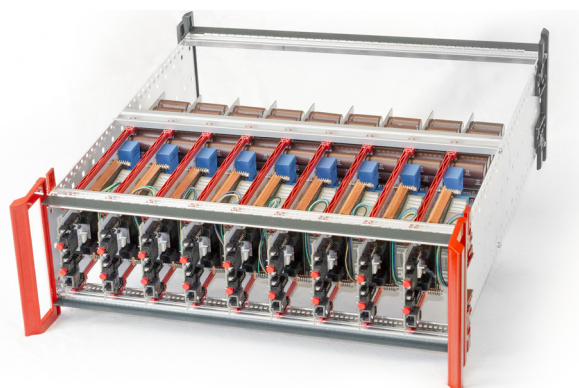

EXTERNAL SENSORS AND ACCESSORIES

In case additional measurements are needed, imperix recommends using external sensors, such as:

- IX 800V DIN-mountable voltage sensor, [here](#).
- IX 50A DIN-mountable current sensor, [here](#).



Alternatively, one voltage measurement is also available on the optional sideboard, which is present in all pre-assembled systems. The sideboard also provides means for active fan speed control, temperature monitoring and the control of a bus pre-charge circuit.

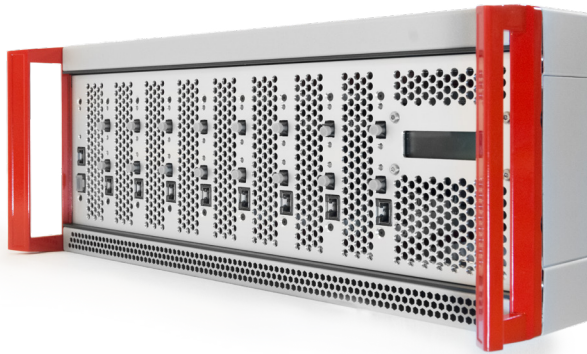

DESIGN CUSTOMIZATION

On request, modules customization or special designs can be implemented. Please consult with imperix sales team for more information.

RELATED PRODUCTS

Module	DC link voltage	Cooling	Current rating
PEB 8032A	800 V _{DC}	Forced Air	32A
PEB 4046A	400 V _{DC}	Forced Air	46A
PEB 80XXW	800 V _{DC}	Water exchanger	?
PEB 40XXW	400 V _{DC}	Water exchanger	?

DETAILED PINOUTS

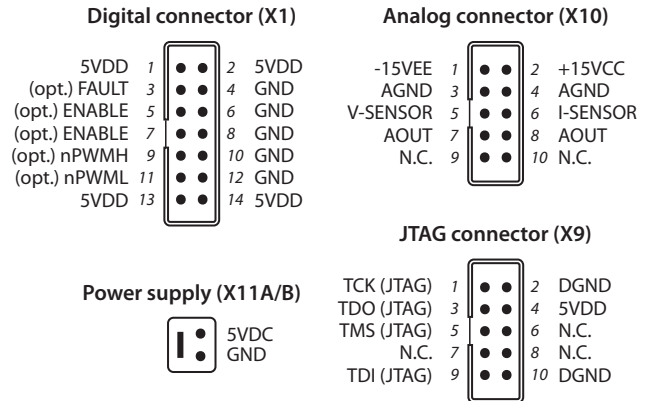

ANALOG OUTPUT CONNECTOR PINOUT

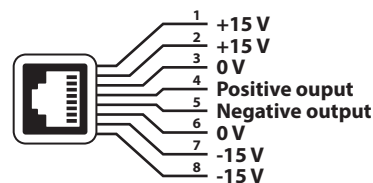

These modules must be used in electric/electronic equipment with respect to applicable standards and safety requirements and in accordance with the operating instructions. Caution, risk of electrical shock! When using the devices, certain parts of the modules may carry hazardous voltages (e.g. power supplies, busbars, etc.). Disregarding this warning may lead to severe injury or cause serious damage. All conducting parts must be inaccessible after installation.

CONTACT

imperix SA

Rue de l'Industrie 17
1950 Sion, Switzerland
phone: +41 (0)27 552 06 60
fax: +41 (0)27 552 06 69
www.imperix.ch, sales@imperix.ch

ABOUT US

Imperix SA (Ltd.) is a company established in Sion, Switzerland. Its name is derived from the Latin verb imperare, which stands for controlling and refers to the company's core business: the control of power electronic systems. Imperix SA commercializes hardware and software solutions dedicated to the fast and secure implementation of pilot systems and plants in the field of power conversion, energy storage and smart grids.

NOTE

While every effort has been made to ensure the accuracy of this publication, no responsibility can be accepted for errors or omissions. Data may change, as well as legislation, and the reader is strongly advised to obtain copies of the most recently issued regulations, standards, and guidelines. This publication does not form the basis of a contract. Copyright 2016. All rights reserved.